

Rittal – The System.

Faster – better – everywhere.

► Hygienic Design Enclosures Superior Cleanability



ENCLOSURES

POWER DISTRIBUTION

CLIMATE CONTROL

IT INFRASTRUCTURE

SOFTWARE & SERVICES



Rittal – The System.

Faster – better – everywhere.

Hygienic design compact enclosures can be wall mounted with the HD system accessories.

Hygienic design control and monitoring, consoles, and support arms.

Hygienic design large system enclosures and accessories.

Climate control outside the hygiene zone

Rittal Chillers can supply the air/water heat exchangers in the hygiene zone and the LCP in the data center with the required cooling water.

Air to Water Heat Exchangers

keep your systems cool using in-house chilled water or Rittal water chillers. No more clogged filters or replacing dirty filters.

Hygienic Design Compact Enclosures and Terminal Boxes can be machine mounted with the HD system accessories.

ENCLOSURES

POWER DISTRIBUTION

CLIMATE CONTROL

One-stop shop for multiple solutions and optimum processes

Different enclosure solutions are needed for the various locations inside a food and beverage production facility. From enclosures that can withstand frequent washdowns on the factory floor to the IT infrastructure in the data center, Rittal has the right solution to protect your sensitive controls and electronic equipment.

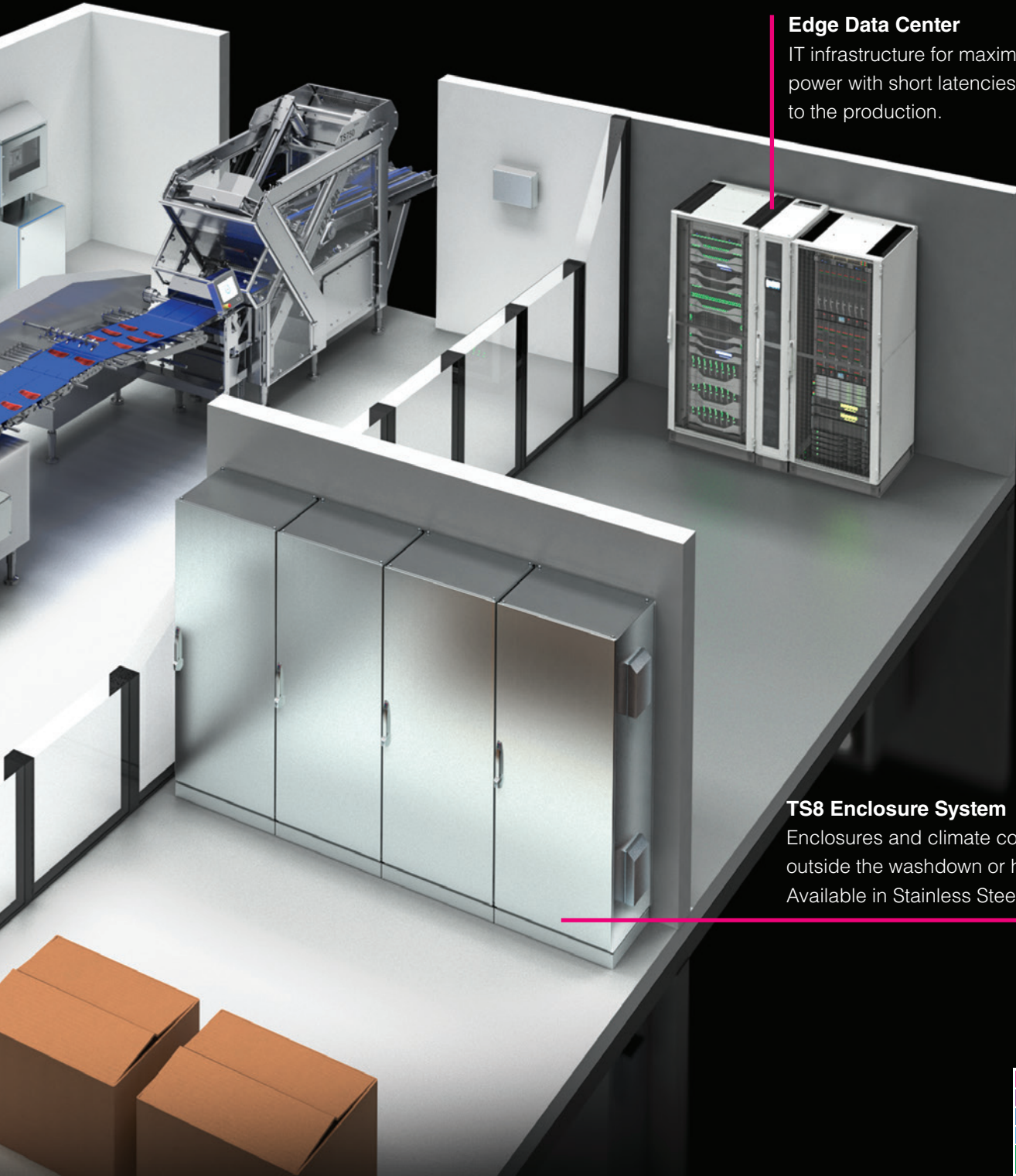

Edge Data Center

IT infrastructure for maximum computing power with short latencies, located close to the production.

TS8 Enclosure System

Enclosures and climate control solutions for outside the washdown or hygienic zone. Available in Stainless Steel or Carbon Steel.

IT INFRASTRUCTURE

SOFTWARE & SERVICES



Hygienic standards for high productivity and reliability

“Rittal – The System.” stands for cleverly thought-out system solutions for hygienic production in the food industry. Particularly in open processes, where the resistance of the seal to detergents and disinfectants is crucial, it is vital for the production plant to be equipped with optimized enclosures, terminal boxes and command panels.



The Rittal Hygienic Design for food safety is based on:

European standards and directives

- EN 1672-2:2005 Food machinery/ General design principles/Part 2: Hygiene requirements
- EN ISO 14 159 2004 Safety of machinery – Hygiene requirements for the design of machinery
- EN 16 001 Energy management to improve energy efficiency
- Machinery directive 2006/42/EC binding
- Document 13 EHEDG guideline on the hygienic design of apparatus for open processes, prepared in collaboration with 3-A and NSF International

EU regulations

- 852/2004 on the hygiene of food-stuffs
- 853/2004 specific hygiene rules for food of animal origin
- 854/2004 specific rules for the organization of official controls on products of animal origin intended for human consumption
- 1935/2004 on materials and articles intended to come into contact with food

Decide for yourself what is important.

Rittal Hygienic Design boosts operational hygiene

- Reduces the use of C&D agents
- Optimizes cleaning results
- Ensures higher productivity
- Minimizes risks
- Increases energy efficiency (CO2 footprint)

All terminal boxes and compact enclosures are cULus listed.



NG 08075
NG 11129



Hygiene geprüft
hygiene tested



Cleanliness assured

Terminal boxes and compact enclosures in Hygienic Design (HD) are key elements in the design of open processes in the food industry and clean rooms due to their ease of cleaning. Compatible accessories such as wall spacer brackets and HD-compatible cable glands complete the range. If you have specific requirements, "Rittal – The System." is sure to have the right solution.

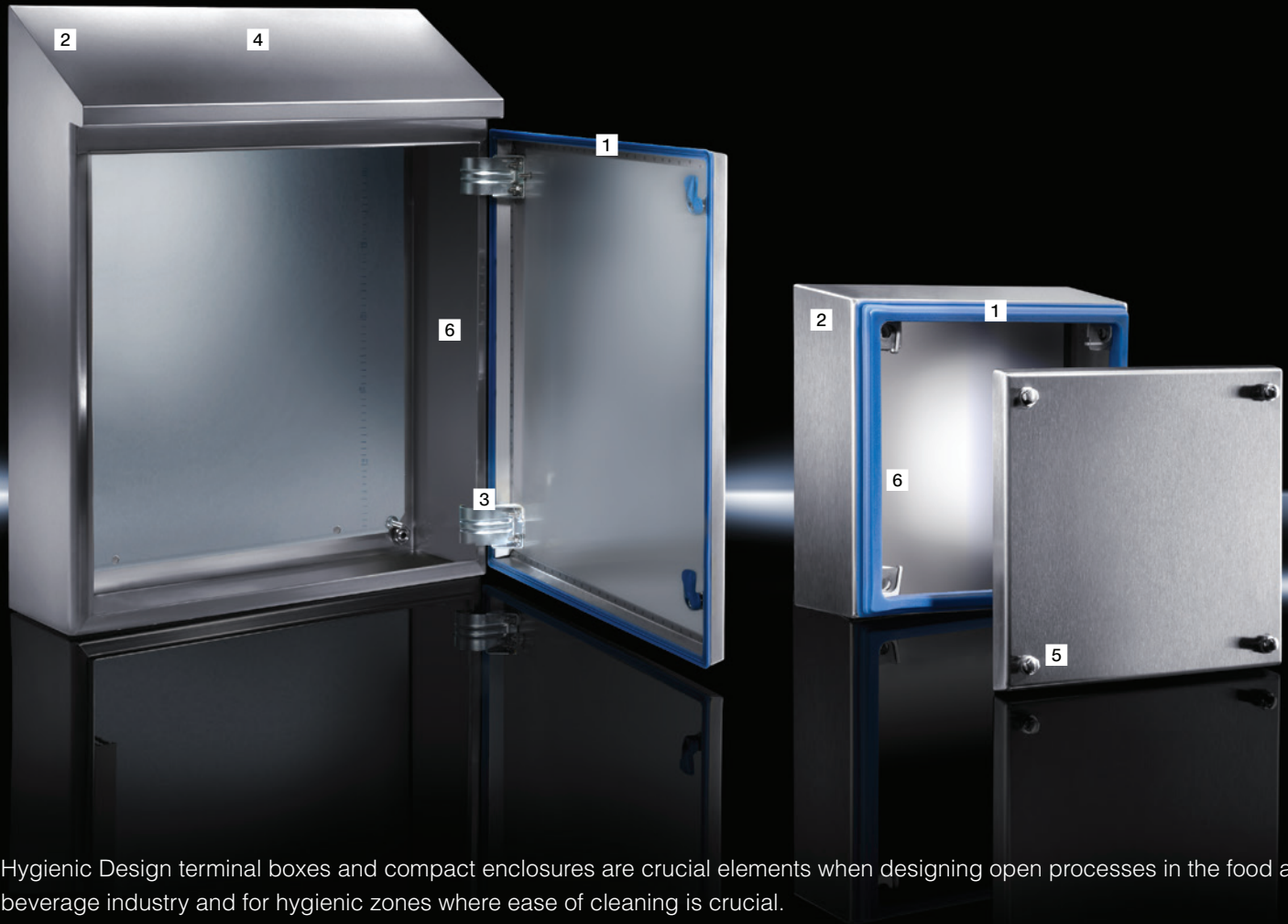

Hygienic Design terminal boxes and compact enclosures are crucial elements when designing open processes in the food and beverage industry and for hygienic zones where ease of cleaning is crucial.

- 1** Silicone seal: Highly resistant to aggressive media; easily replaced
- 2** Inclined roof: Prevents pooling of liquids, and ensures that surfaces are readily visible
- 3** Slot-free design – No hollow spaces between the enclosure and door
- 4** Fine brushed surface finish makes it easier to clean: Fully sealed enclosures with a uniform 400 grain size brushed finish for a uniform surface roughness of $< 8 \mu\text{m}$
- 5** Easy-to-clean lock system: Tailored to the requirements of the food and consumables industry
- 6** Interior installation:
 - Attachment points for fitting interior installation rails, for individual installation in the depth with HD compact enclosures
 - HD terminal boxes can accommodate support rails and KL mounting plates, thanks to the flexible 6.25 mm pitch pattern of installation holes

Silicone seal

- All-around external, joint-free silicone seal
- Easy to replace
- Guides and fixes the lid to the screw fasteners
- All-around tilt for terminal boxes
 - Enclosure: 3°
 - Lid: 10°

Interior configuration

- Hole pitch of 6.25 mm for greater flexibility
- KL support rails and mounting plates can be fitted directly

Hinges and seal

- Hinges that are inside the sealing zone create an exceptionally easy-clean design on the outside
- The durable all-around, external silicone seal effectively prevents all gaps
- Installed sealing frames are easily replaced
- No external cavity between enclosure and door
- Seal dyed blue to clearly distinguish it from foodstuffs

Screw fastener

- Captive
- With external seal
- Hexagon shape for perfect cleanliness

Lock and lock insert

- External parts made of stainless steel
- Material and shape allow easy and reliable cleaning

Roof angled forwards

- The roof angled forwards by 30° on compact enclosures prevents objects from being deposited on it
- Is easily inspected
- Allows fluids to drain off rapidly



Hygienic Design

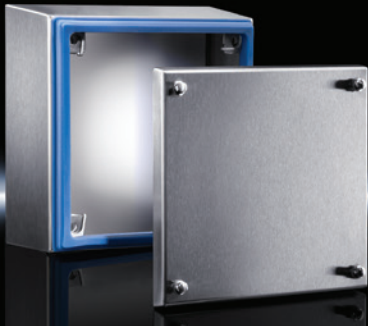

Material:

- Enclosure and cover: Stainless steel 1.4301 (AISI 304)
- Mounting bracket: Sheet steel, zinc-plated, passivated, 2.0 mm
- Screw plug: Stainless steel
- Seal: Silicone, compliant with FDA Guideline 21 CFR 177.2600

Surface finish:

- Enclosure and cover: Brushed, grain 400, peak-to-valley height < 0.8 µm
- Seal: Blue, dyed (RAL 5010)

Protection category IP to IEC 60 529:

- IP 66

Protection category IP to DIN 40 050-9:

- IP 69K

Protection category NEMA:

- NEMA 13
- NEMA 4X
- NEMA 3R

Supply includes:

- Enclosure of all-around solid construction
- Cover
- Mounting bracket (pre-assembled)
- Seal and screw plug (supplied loose)

Approvals:

- UL
- cUL

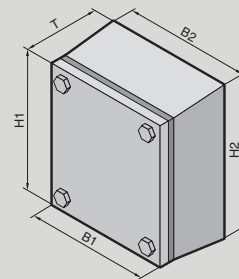

Terminal boxes

Width (front) (B1) in. (mm)	Packs of	5.9" (150)	5.9" (150)	7.8" (200)	11.8" (300)	15.7" (400)	15.7" (400)	Page
Width (rear) (B2) in. (mm)		6.7" (172)	6.9" (177)	8.9" (227)	12.8" (327)	16.6" (427)	16.8" (427)	
Height (front) (H1) in. (mm)		5.9" (150)	5.9" (150)	7.8" (200)	7.8" (200)	7.8" (200)	11.8" (300)	
Height (rear) (H2) in. (mm)		6.7" (172)	6.9" (177)	8.9" (227)	8.9" (227)	8.9" (227)	12.8" (327)	
Depth (T) in. (mm)		3.1" (80)	4.7" (120)	4.7" 120	4.7" 120	4.7" 120	4.7" 120	
Model No.	1 pc(s).	1670.600	1671.600	1672.600	1674.600	1675.600	1676.600	
Weight lbs. (kg)		3.1 lbs. (1.7)	4.1 lbs (2.2)	6.9 lbs. (3.0)	8.1lbs. (4.0)	11lbs. (5.0)	13lbs. (5.9)	

Accessories

HD wall spacer bracket	1 pc(s).	4000.100	4000.100	4000.100	4000.100	4000.100	4000.100	23
Mounting plates	1 pc(s).	1560.700	1560.700	1562.700	1563.700	1564.700	1568.700	
Support rails TS 35/7.5	10 pc(s).	2314.000	2314.000	2315.000	2316.000	2317.000	2317.000	
HD cable gland		see page						27



Fire extinguisher enclosure HD

see page 13

NEW

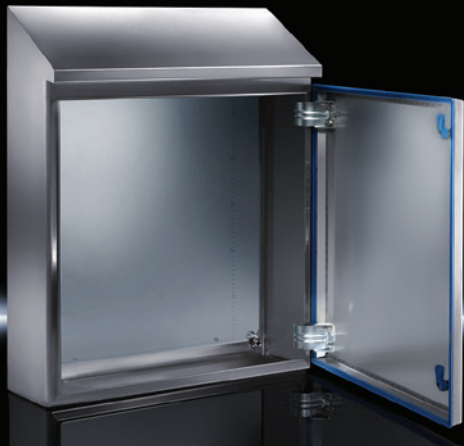

Material:

- Enclosure and cover: Stainless steel 1.4301 (AISI 304)
- Mounting bracket: Sheet steel, zinc-plated, passivated, 2.0 mm
- Screw plug: Stainless steel
- Seal: Silicone, compliant with FDA Guideline 21 CFR 177.2600

Surface finish:

- Enclosure and cover: Brushed, grain 400, peak-to-valley height < 0.8 µm
- Seal: Blue, dyed (RAL 5010)

Protection category IP to IEC 60 529:
- IP 66

Protection category IP to DIN 40 050-9:
- IP 69K

Protection category NEMA:
- NEMA 13
- NEMA 4X
- NEMA 3R

Supply includes:

- Enclosure of all-around solid construction
- Door with inserted seal
- Door hinged on the right, may be swapped to the left
- Mounting plate

Approvals:

- UL
- cUL

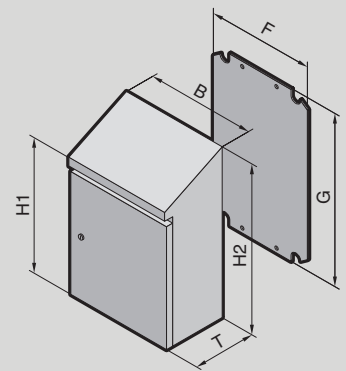

Compact enclosure HD

Width (B) in. (mm)	Packs of	8.6" (220)	15.3" (390)	15.3" (390)	20" (510)	24" (610)	24" (610)
Height (front) (H1) in. (mm)		13.7" (350)	16.9" (430)	25.5" (650)	21.6" (550)	16.9" (430)	25.5" (650)
Height (rear) (H2) in. (mm)		17.2" (437)	21.6" (549)	30.2" (769)	26.3" (669)	23.6" (601)	30.2" (769)
Depth (T) in. (mm)		6.1" (155)	8.2" (210)	8.2" (210)	8.2" (210)	11.8" (300)	8.2" (210)
Mounting plate width (F) in. (mm)		6.3" (162)	13.1" (334)	13.1" (334)	17.6" (449)	21.6" (549)	21.6" (549)
Mounting plate height (G) in. (mm)		10.8" (275)	13.9" (355)	22.4" (570)	18.5" (470)	13.9" (355)	22.4" (570)
Model No.	1 pc(s).	1302.600	1306.600	1308.600	1307.600	1320.600	1310.600
Weight lbs. (kg)		14.8 lbs. (6.6)	32.6 lbs. (14.7)	39.7 lbs. (17.9)	43.6 lbs. (19.7)	47.1 lbs. (21.7)	60.6 lbs. (27.4)

Width (B) mm	Packs of	31.8" (810)	31.8" (810)	31.8" (810)	31.8" (810)	24" (610)	29.9" (760)
Height (front) (H1) in. (mm)		16.9" (430)	25.5" (650)	41.3" (1050)	49.2" (1250)	31.8" (810)	31.8" (810)
Height (rear) (H2) in. (mm)		21.6" (549)	32.3" (821)	48" (1221)	55.9" (1421)	36.5" (929)	38.6" (981)
Depth (T) in. (mm)		8.02" (210)	11.8" (300)	11.8" (300)	11.8" (300)	8.2" (210)	11.8" (300)
Mounting plate width (F) in. (mm)		29.4" (749)	29.1" (739)	29.1" (739)	29.1" (739)	21.6" (549)	27.7" (704)
Mounting plate height (G) in. (mm)		22.4" (570)	13.9" (355)	37.5" (955)	45.4" (1155)	28.7" (730)	28.7" (730)
Model No.	1 pc(s).	1314.600	1315.600	1316.600	1317.600	4000.012	4000.014
Weight lbs. (kg)		56.3 lbs. (25.5)	85.1 lbs. (39.0)	132.7 lbs. (60.1)	156.8 lbs. (71.0)	70.8 lbs. (32)	74.1 lbs. (34)

Accessories

HD wall spacer bracket	1 pc(s).	4000.100	23
HD cable gland		see page	27
HD hinge	2 pc(s).	4000.130	21
Rails for interior installation	4 pc(s).	see page	26
HD T-handle	1 pc(s).	4000.065	20

Hygienic control and monitoring

Command panels and printer enclosures play a key role in the decentralized control and monitoring of open processes in the food and luxury goods industry. Their functional design means that standard commercially available PC components such as printers, monitors and label printers, are easily and securely integrated into the production process.



Silicone seal

- All-around external, joint-free silicone seal
- Easy to replace
- Compliant with FDA Guideline 21 CFR 177.2600
- Blue, dyed (RAL 5010)

Easy monitoring

- Large visible area with inset and sealed polycarbonate window in the door
- Screwed-fastened mounting plate with holes for VESA 75 and 100 connection
- Attachment of monitors of up to 24"

User-friendly design

- Enclosure tilted forwards by 3° – to allow liquids to drain off reliably whilst cleaning
- for the support of keyboards during production
- Component shelves with telescopic slides for easy integration of computers or e.g. label printers
 - Interior installation rails allow the installation of additional component shelves

Modular combination

- Connection component for combining a command panel and a printer enclosure into a complete PC enclosure
- Integral drilled holes with a diameter of 40 mm for easy cable entry with connectors



Hygienic Design



Material:

- Stainless steel 1.4301 (AISI 304)
- Enclosure: 1.5 mm
- Door: 2.0 mm
- Lock inserts: Stainless steel 1.4301 (AISI 304)
- Seal: Silicone, compliant with FDA Guideline 21 CFR 177.2600

Surface finish:

- Brushed, grain 400, $R_A < 0.8 \mu\text{m}$
- Seal: Blue, dyed (RAL 5010)

Protection category IP to IC 60 529:

- Enclosure top: IP 66
- Enclosure bottom: IP 66

Protection category IP to DIN 40 050-9:

- Enclosure top: IP 59K
- Enclosure bottom: IP 69K

Console supply includes:

- Roof angled forwards by 30°
- Door with integrated polycarbonate pane for monitor; compartment with screw-fastened mounting plate with holes for VESA connection 75 and 100
- Viewing window: polycarbonate
- Mounting plate height-adjustable for screens up to 24"

Pedestal supply includes:

- Roof angled forwards by 3°, suitable as a support rest or for keyboard installation
- Component shelf spray-finished, pull-out and height-adjustable with side punched rails

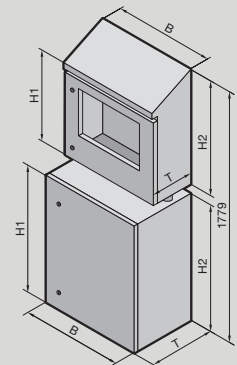

HD production data cabinet, modular

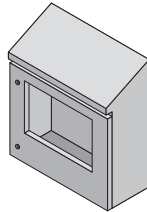
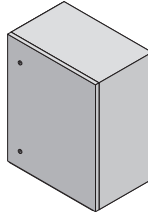
				
	Packs of	Console	Pedestal	Page
Width (B) in. (mm)		31.8" (810)	31.8" (810)	
Height (front) (H1) in. (mm)		27.2" (692)	33.9" (863)	
Height (rear) (H2) in. (mm)		33.3" (848)	34.9" (888)	
Depth (T) in. (mm)		10.4" (266)	19.5" (496)	
Model No.	1 pc(s).	4000.062	4000.064	
Weight lbs. (kg)		73.3 lbs. (33.2)	119.7 lbs. (54.2)	

Accessories

HD keyboard support	1 pc(s).	4000.072	–	24
HD wall spacer bracket	1 pc(s).	4000.100	–	23
HD hinge	2 pc(s).	4000.130	4000.130	21
HD cable gland		see page	see page	27
HD connection components	1 pc(s).	4000.066	4000.066	24
HD T-handle	1 pc(s).	4000.065	4000.065	20
HD flap	1 pc(s).	4000.068	4000.068	24
HD leveling feet		see page	see page	19

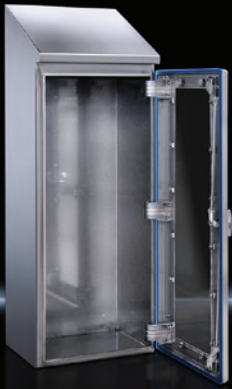

Design:

- Roof angled forwards by 30°

Benefits:

- Hygienic, hose-proof storage of fire extinguishers
- Time and cost savings thanks to simple, effective cleaning options
- Fire extinguisher is easily removed with one hand thanks to the T-handle
- Quick inventory check with the integral viewing door

Material:

- Enclosure and door: Stainless steel 1.4301 (AISI 304)
- Handle and lock: Stainless steel 1.4301 (AISI 304)
- Viewing window: Polycarbonate
- Seal: Silicone, compliant with FDA Guideline 21 CFR 177.2600

Surface finish:

- Enclosure and door: Brushed, grain 400, peak-to-valley height < 0.8 µm
- Seal: Blue, dyed (RAL 5010)

Protection category IP to IEC 60 529:

- IP 66

Protection category IP to DIN 40 050-9:

- IP 59K

Supply includes:

- Enclosure of all-around solid construction
- Door with viewing window and inserted seal
- Interchangeable door hinge
- T-handle with 3-point lock system

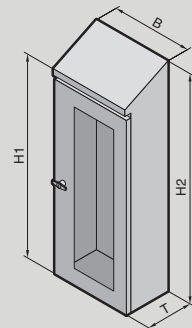

Fire extinguisher enclosure HD

Width (B) in. (mm)	Packs of	11.8" (300)	15.3" (390)	Page
Height (front) (H1) in. (mm)		25.5" (650)	33.0" (840)	
Height (rear) (H2) in. (mm)		30.2" (769)	39.7" (1010)	
Depth (T) in. (mm)		8.2" (210)	11.8" (300)	
Viewing window width in. (mm)		4.7" (120)	7.4" (190)	
Viewing window height in. (mm)		19.0" (482)	26.3" (670)	
Model No.	1 pc(s).	4000.073	4000.075	
Weight lbs. (kg)		30 lbs. (13.5)	48.5 lbs. (22.0)	

Accessories

HD wall spacer bracket	1 pc(s).	4000.100	4000.100	23
HD leveling feet		see page	see page	19
HD hinge	2 pc(s).	4000.130	4000.130	21

System partner for the food industry

Create the optimum conditions for successful audits by IFS 6 and trading firms with the Rittal System for Hygienic Design. The baying system and production data enclosures can be integrated perfectly into your production clean rooms. Thanks to the infinite possibilities for baying, even complex control systems for open processes are no longer a problem.



Seal

- Silicone profile seal between door, side panels and enclosure
- Joint-free, all-around external seal – simple to replace
- Seal dyed blue to clearly distinguish it from foodstuffs
- Silicone seal for the angled roof and baying frame comprising self-adhesive, jointed profile lengths and rectangular profiles

Door

- Hinges that are inside the sealing zone create an exceptionally easy-clean design on the outside
- Two locking rods, external parts in stainless steel, for secure and sealed closing
- Easy-to-clean lock insert – can be exchanged for a T-handle

Designing

- Integrated, non-detachable rear panel guarantees reliable hygiene and sealing in an area which is difficult to monitor
- Side panels screw-fastened from the inside
- Door and enclosure with all-round internal system punching for installation of accessories
- Door hinged on the right, may be swapped to the left
- Solid base
- Mounting plate from TS 8 baying system
- Rounded edge folds on the door and side panels as a significant contribution to easy cleaning
- Open top for mounting of angled roof
- A special angled roof can be manufactured upon request for combinations of two 600 or 800 mm wide enclosures

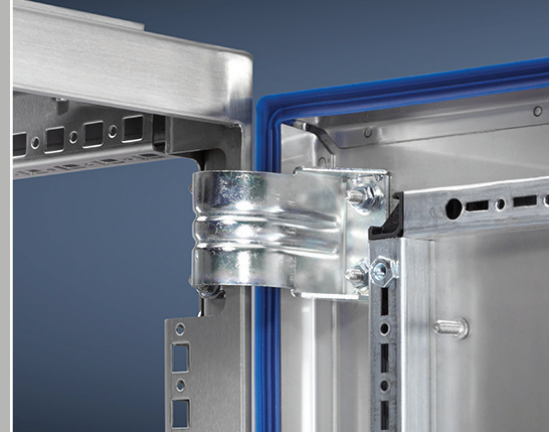
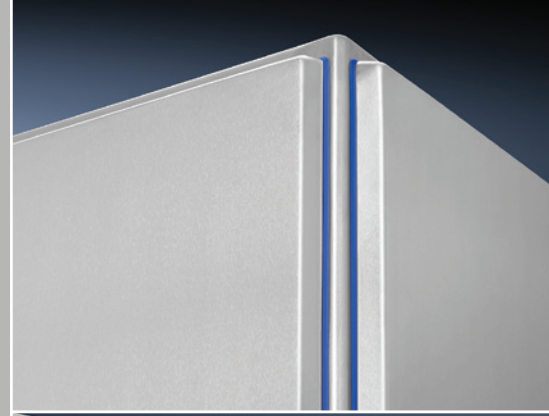

Hygienic Design



Material:

- Enclosure and cover: Stainless steel 1.4301 (AISI 304)
- Lock inserts HD: Stainless steel 1.4404 (AISI 316L)
- Seal: Silicone, compliant with FDA Guideline 21 CFR 177.2600
- Mounting plate: Sheet steel

Surface finish:

- Enclosure and cover: Brushed, grain 400, peak-to-valley height < 0.8 µm
- Mounting plate: Zinc-plated
- Seal: Blue, dyed (RAL 5010)

Protection category IP to IEC 60 529:

- IP 66

Protection category IP to DIN 40 050-9:

- IP 59K

Supply includes:

- Enclosure frame with welded rear panel gland plate
- Door with inserted seal
- R/h door hinge with single-door enclosures, may be swapped to opposite side
- Mounting plate

Please observe the product-specific scope of supply.

Optional

- HD supporting structure with leveling

Note:

- To achieve a protection category of IP 66/IP 59K, the HD versions of the side panel, roof and (where applicable) baying frame must be selected.

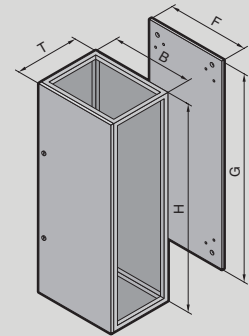

HD System Enclosure

Width (B) in. (mm)	Packs of	15.7" (400)	23.6" (600)	31.5" (800)	47.2" (1200)	Page
Height (front) (H) in. (mm)		70.8" (1800)	70.8" (1800)	70.8" (1800)	70.8" (1800)	
Depth (T) in. (mm)		19.6" (500)	19.6" (500)	19.6" (500)	19.6" (500)	
Mounting plate width (F) in. (mm)		11.7" (299)	19.6" (499)	27.5" (699)	43.2" (1099)	
Mounting plate height (G) in. (mm)		66.7" (1696)	66.7" (1696)	66.7" (1696)	66.7" (1696)	
Model No.	1 pc(s).	4000.485	4000.685	4000.885	4000.285	
Weight lbs (kg)		152.1 lbs. (69.0)	196.3 lbs. (89.0)	238.1 lbs. (108.0)	390.3 lbs. (177.0)	

Accessories

HD side panels	2 pc(s).	4000.185	4000.185	4000.185	4000.185	19
HD baying frame	1 pc(s).	4000.785	4000.785	4000.785	4000.785	19
HD mounting plate infill	1 pc(s).	4000.508	4000.508	4000.508	4000.508	21
HD attachment	1 pc(s).	4000.545	4000.565	4000.585	4000.525	21
HD T-handle	1 pc(s).	4000.065	4000.065	4000.065	4000.065	20
HD leveling feet		see page	see page	see page	see page	19
HD hinge	2 pc(s).	4000.130	4000.130	4000.130	4000.130	21
HD viewing window	1 pc(s).	4000.080	4000.080	4000.080	4000.080	20
LED system light	1 pc(s).	2500.110	2500.110	2500.110	2500.110	

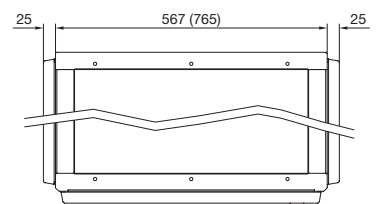
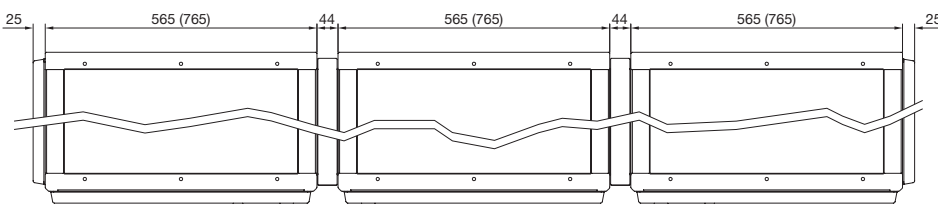

Air/Water Heat Exchangers

Hygienic Design



An easy-to-clean enclosure climate control solution is now available for hygiene-critical production zones in the food and beverage industry.

- Hygienic design simplifies cleaning procedures and guarantees food safety
- Protection category IP 56/59 if correctly fitted – suitable for high-pressure and steam-jet cleaning
- Enclosure made from 1.4301 (AISI 304) stainless steel with the roof tilted forwards by 30°
- Water connections made from stainless steel 1.4301 (AISI 304)
- Suitable for use in the food industry to DIN EN 1672-2:2009



Hygienic Design



Air/water heat exchanger for hygienically sensitive production zones in the food and consumables industry – the optimum addition to the Rittal Hygienic Design range. The cleaning-friendly design reduces the risk of contamination and ensures food safety.

Benefits:

- Easy-to-clean, hygienic design
- A roof tilt of 30° prevents objects from being deposited on it, and allows liquids to run off quickly.
- All-around external, replaceable silicone seal prevents the accumulation of dirt between the enclosure and the air/water heat exchanger.

Material:

- Enclosure and cover: Stainless steel 1.4301 (AISI 304)

Surface finish:

- Enclosure: Brushed, grain 400, peak-to-valley height < 0.8 µm

Protection category IP to IEC 60 529:

- IP 56/59

Protection category NEMA:

- NEMA 4X

Cooling medium:

- Water (see internet for specifications)

Supply includes:

- Fully wired ready for connection (plug-in terminal strip)
- Drilling template
- Sealing and assembly parts

Note:

- To achieve a protection category of IP 66/59 to IEC 60 529, the ingress of leakage air through the condensate discharge opening must be completely prevented.

HD Air/Water Heat Exchanger

Model No.	Packs of	3214.700	3215.700
Temperature control	Thermostat-controlled magnetic valve	■	■
Total cooling output L35 W10, 200 l/h (kW)		2047 BTU (0.6)	3412 BTU (1)
Total cooling output L35 W10, 400 l/h kW		2217 BTU (0.65)	4095 BTU (1.2)
Power consumption P _{el} 50/60 Hz W		36/37	83/85
Rated operating voltage V, ~, Hz		230, 1~, 50/60	230, 1~, 50/60
Width in. (mm)		8.6" (220)	8.5" (215)
Height in. (mm)		20.7" (526)	38.6" (982)
Depth in. (mm)		3.9" (100)	3.9" (100)
Rated current max.A		0.16 / 0.14	0.38 / 0.47
Pre-fuse A		2	4
Operating temperature range		+34F...+158F (+1°C...+70°C)	+34F...+158F (+1°C...+70°C)
Setting range		+68F...+140F (+20°C...+60°C)	+68F...+140F (+20°C...+60°C)
Water inlet temperature		+34F...+86F (+1°C...+30°C)	+34F...+86F (+1°C...+30°C)
Water connection	G 3/8" external thread	■	■
Permissible operating pressure (p. max.) bar		14-145 PSI (1 - 10)	14-145 PSI (1 - 10)
Air throughput of fans (unimpeded air flow), Internal circuit 50/60 Hz m³/h		164/182 CFM (280 / 310)	400/432 CFM (680 / 735)
Weight (kg)		13.3 lbs. (6.0)	30.9 lbs. (14.0)

Hygienic Design

Accessories

HD leveling feet

for HD system enclosure and HD compact enclosure

Benefits:

- Minimizes cleaning time thanks to fully covered, permanently sealed threads
- Compensation of floor inclines up to an angle of 10° thanks to flexible base
- Baying can even be achieved on sloping floors, thanks to a large leveling range
- Design to EHEDG standards

Material:

- Stainless steel 1.4301 (AISI 304)

Load capacity:

- Max. 7000 N static per leveling foot

Supply includes:

- Assembly parts and seals

Design	Thread	Adjustment range in. (mm)	Packs of	Model No.
without base mount	M12	4.8"-6.8" (122-175)	4 pc(s).	4000.240
with base attachment	M12	4.8"-6.8" (122-175)	4 pc(s).	4000.250



HD side panels

for HD system enclosure

Material:

- Stainless steel 1.4301 (AISI 301), 2.0mm

Supply includes:

- With assembly parts for screw-fastening from the inside

Note:

- Depending on the fitted side panel, the overall width of the enclosure is increased by 25 mm

For enclosure height in. (mm)	For enclosure depth in. (mm)	Packs of	Model No.
70.8" (1800)	19.6" (500)	2 pc(s).	4000.185

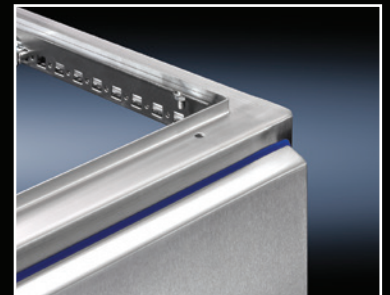
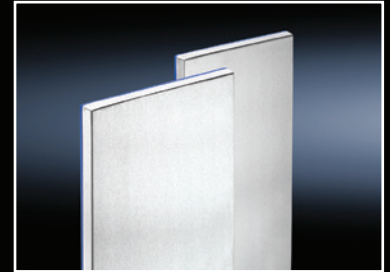

HD baying frame

for HD system enclosure

Material:

- Stainless steel 1.4301 (AISI 304)

Supply includes:

- Seal for HD angled roof
- Assembly parts

Note:

- Depending on the fitted side panel, the overall width of the enclosure is increased by 44 mm

For enclosure height mm	For enclosure depth mm	Packs of	Model No.
70.8" (1800)	19.6" (500)	1 pc(s).	4000.785



Hygienic Design

Accessories



HD viewing window

for the protection of switches or displays.

Benefits:

- Large viewing panel
- Gap-free transition between the viewing window and the frame
- External hinge
- With T-handle for easy opening without a key

Material:

- Frame: Stainless steel 1.4301 (AISI 304)
- Seal: Silicone, compliant with FDA Guideline 21 CFR 177.2600
- Viewing window: Polycarbonate

Supply includes:

- 2 hinges
- T-handle

Width in. (mm)	Height in. (mm)	Depth in. (mm)	Viewing area in. (mm)	Packs of	Model No.
20.3" (518)	17.1" (436)	.9" (23)	16.1"x12.5" 410x320	1 pc(s).	4000.080



HD T-handle

For easy opening without a key. May be exchanged in all enclosures with cam lock.

Material:

- Stainless steel 1.4301 (AISI 304)

Packs of	Model No.
1 pc(s).	4000.065



HD cam lock

Hygienic Design variant for easy, safe cleaning.

Applications:

- Compact enclosures AE stainless steel (except AE 1017.XXX and AE 1019.XXX).
- May be integrated into customized applications, e.g. covers of machine panels.

Material:

- Stainless steel 1.4404 (AISI 316L)

Packs of	Model No.
1 pc(s).	2304.010

Accessories:

- Enclosure key HD, see page 20



HD enclosure key

For HD cam lock

Note:

- Enclosure, case and lock systems are supplied as standard with matching keys

Packs of	Model No.
1 pc(s).	2549.600

Hygienic Design

Accessories

HD bit

for universal key 2549.500

Packs of	Model No.
1 pc(s).	2549.510



HD hinge

To be used in exchange in HD enclosures with internal hinges.

Material:

– Stainless steel 1.4301 (AISI 304)

Supply includes:

– Assembly parts

Packs of	Model No.
2 pc(s).	4000.130

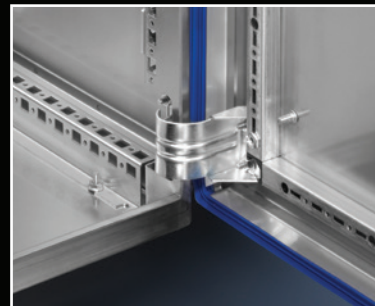

HD attachment for HD system enclosure

Design:

– Roof angled forwards by 30°

Material:

– Stainless steel 1.4301 (AISI 304)

Supply includes:

– Assembly parts

For enclosure width in. (mm)	For enclosure depth in. (mm)	Packs of	Model No.
15.7" (400)	19.6" (500)	1 pc(s).	4000.545
23.6" (600)	19.6" (500)	1 pc(s).	4000.565
31.4" (800)	19.6" (500)	1 pc(s).	4000.585
47.2" (1200)	19.6" (500)	1 pc(s).	4000.525

Also required:

– Side parts HD, see page 21



HD side parts

for HD attachment

Material:

– Stainless steel 1.4301 (AISI 304)

Supply includes:

– Assembly parts

Packs of	Model No.
2 pc(s).	4000.505

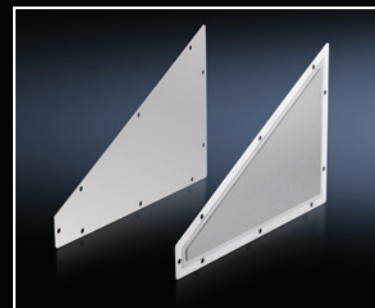

HD mounting plate infill for HD system enclosure

For a continuous mounting surface in bayed suites where the mounting plate is set forward.

Material:

– Sheet steel, 2 mm

Surface finish:

– Zinc-plated

Supply includes:

– Assembly parts

For enclosure height in. (mm)	Packs of	Model No.
70.8" (1800)	1 pc(s).	4000.508



Hygienic Design

Interior Installation-System Enclosure HD

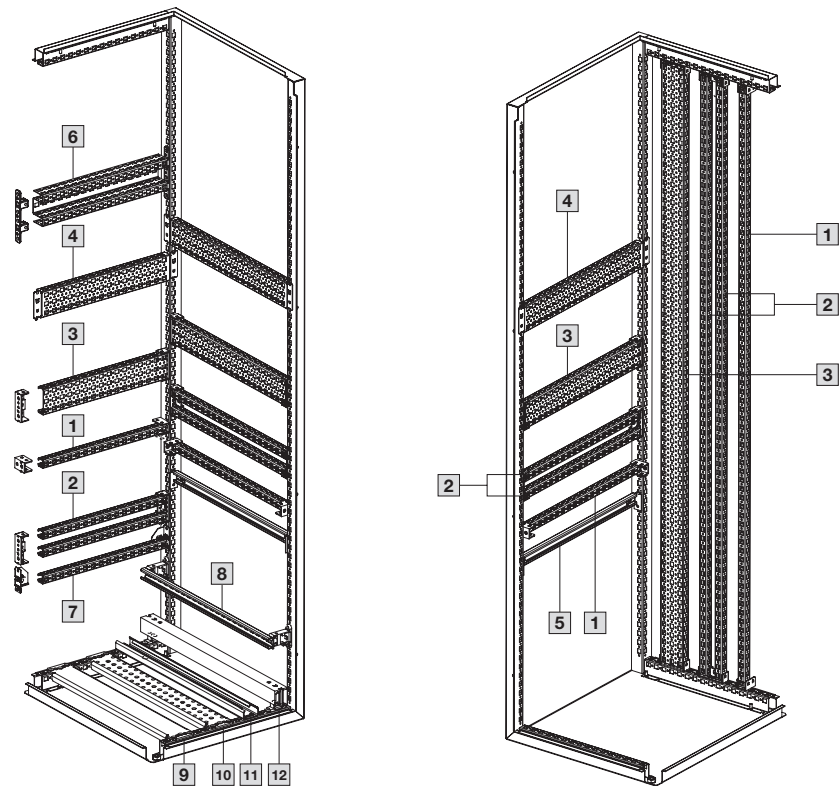
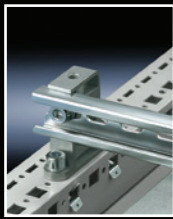
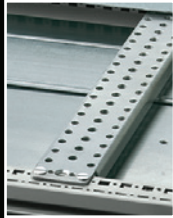
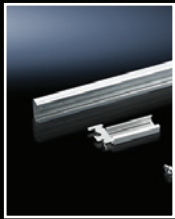
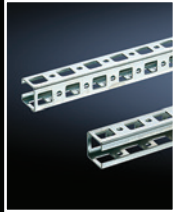
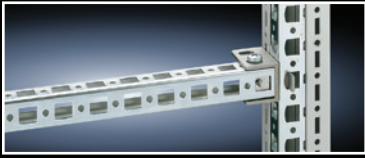

Rail Systems

1	PS punched rail 23 x 23 mm with mounting bracket
2	PS punched rail 23 x 23 mm with support bracket PS (with one or two mounting rails 23 x 23 as an option)
3	PS punched section without mounting flange 23 x 73 mm with support bracket PS
4	PS punched section with mounting flange 23 x 73 mm
5	C rail for TS
6	TS punched section without mounting flange 45 x 88 mm
7	PS punched rail 23 x 23 mm with angle bracket PS
8	C rail 30/15 with bracket/spacer
9	Support rail, unslotted
10	Support rail, slotted
11	System support rail
12	Cable clamp rail – right-angle section

Hygienic Design

Interior Installation-System Enclosure HD

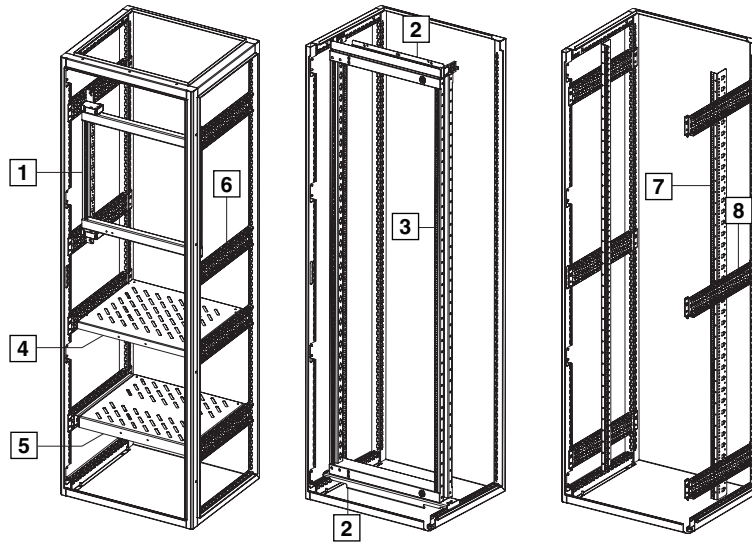

Swing frame, component shelf, mounting angles

1	Swing frame, small, with installation kit
2	Installation kit for swing frames, large, for TS/SE enclosures
3	Swing frame, large, without trim panel, for 600 mm wide enclosure
4	PS punched section with mounting flange 23 x 73 mm
5	Component shelf for frame attachment 100 kg
6	PS punched section with mounting flange 23 x 73 mm
7	Mounting angles – 482.6 mm (19")

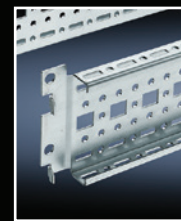
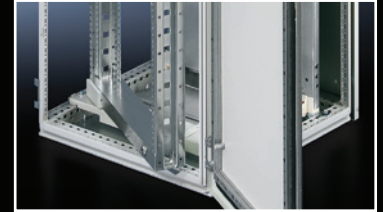

Accessories

HD wall spacer bracket

Benefits:

- Creates space for cleaning behind the enclosure.
- Shorter assembly times by eliminating the need for an all-round seal.
- Greater hygiene safety by avoiding an uncontrollable dead space or gap between the enclosure and wall.
- Mounting on the wall optionally from the enclosure interior via a through-hole (max. M8) or from the rear via an integral M10 thread.

Material:

- Stainless steel 1.4301 (AISI 304)

Supply includes:

- Assembly parts and seals

Note:

- Depending on the size of the enclosure, up to 4 wall spacer brackets are required to ensure sufficiently stable wall mounting

Wall distance in. (mm)	Packs of	Model No.
1.9" (50)	1 ps(s).	4000.100

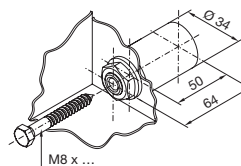

Attachment from inside

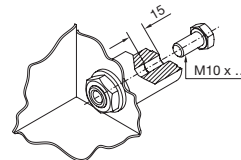

Attachment from outside

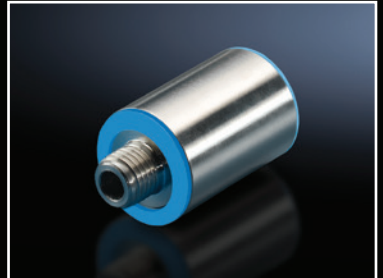

HD wall spacer bracket

Greater distance from the wall to allow cleaning of large surfaces.

Material:

- Console: Stainless steel 1.4301 (AISI 304)
- Spacers: Plastic approved for use with food-stuffs, dyed blue

Supply includes:

- 2 consoles
- Spacer support
- Assembly parts

Wall distance in. (mm)	Packs of	Model No.
5.9" (150)	1 ps(s).	4000.110



Hygienic Design

Accessories



HD connection components for command panels HD, printer enclosures HD

For combining HD command panels and HD printer enclosures into one PC enclosure.

Material:

- Stainless steel 1.4301 (AISI 304)

Supply includes:

- 2 reinforcement plates for enclosure, top
- 4 reinforcement plates for enclosure, bottom (2 for the roof, 2 for the attachment of leveling feet or supporting structure)
- 2 spacer supports with drilled hole Ø 40 mm for cable entry, height 50/45.8 mm
- Assembly parts and seals

Packs of	Model No.
1 ps(s).	4000.066

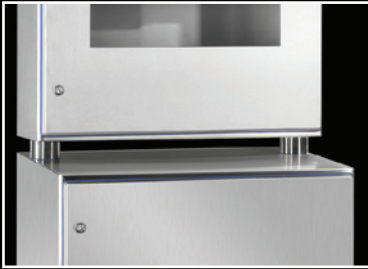

HD keyboard support

To support standard keyboards, including water drain hole.

Material:

- Sheet steel 1.4301 (AISI 304)

Supply includes:

- Spacer support to the enclosure

Width in. (mm)	Depth in. (mm)	Contact surface, width in. (mm)	Contact surface, depth in. (mm)	Packs of	Model No.
22.5" (573)	9.8" (250)	22.4" (570)	7.4" (190)	1 pc(s).	4000.072



HD flap

For rapid access e.g. in order to change the labels.

Material:

- Sheet steel 1.4301 (AISI 304)

Supply includes:

- T-handle
- Seal included
- Hinges and cam lock

Packs of	Model No.
1 pc(s).	4000.068

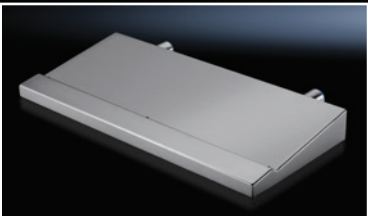

Connector gland, small

For pre-assembled cables with connectors.

- For use with material thickness of up to 4 mm
- Strain relief of the pre-assembled cables can be achieved with cable ties

Material:

- Plastic

Color:

- RAL 9005

Protection category IP to IEC 60 529:

- IP 65 if installed correctly

Supply includes:

- Assembly parts

To fit	Packs of	Model No.
2 cables AWG 2 – AWG 1 (Ø6 – 8 mm)	1 pc(s).	2400.300
3 cables AWG 6 – AWG 3 (Ø4 – 6 mm)	5 ps(s).	2400.500



Hygienic Design

Accessories

Hose-proof hood

To increase the protection category

For fan-and-filter units/outlet filters. Easy cleaning thanks to exterior silicone seal compliant with FDA Guideline 21 CFR 177.2600.

Material:

- Stainless steel
- Silicone

Protection category IP to IEC 60 529:

- IP 56 when fitted over fan-and-filter unit/outlet filter with filter mat

To fit Model No.	W x H x D in. (mm)	Protection category	Packs of	Model No.
3237...	5.9" x 9" x 1.5" (150 x 230 x 40)	NEMA 12	1 pc(s).	3237.080
3238...	6.9" x 9.6" x 2.1" (176 x 245 x 55)	NEMA 1 NEMA 12 NEMA 3 NEMA 4 NEMA 4X	1 pc(s).	3238.080
3239...	9.1" x 12.9" x 2.1" (233 x 330 x 55)	NEMA 1 NEMA 12 NEMA 3 NEMA 4 NEMA 4X	1 pc(s).	3239.080
3240.../3241...	11.1" x 15.3" x 3.3" (282 x 390 x 85)	NEMA 1 NEMA 12 NEMA 3 NEMA 4 NEMA 4X	1 pc(s).	3240.080
3243.../3244...	13.7" x 18.8" x 4.3" (350 x 480 x 110)	NEMA 1 NEMA 12 NEMA 3 NEMA 4 NEMA 4X	1 pc(s).	3243.080
3245...	13.7" x 18.8" x 6.2" (350 x 480 x 160)	NEMA 1 NEMA 12 NEMA 3R	1 pc(s).	3245.080

Silicone Seal

for TS, AE

in exchange for a damaged PU seal. This makes it more resistant to cleaning agents and disinfectants

Material:

- Silicone foam profile

Color:

- white

Length ft. (m)	Packs of	Model No.
82 ft. (25)	1 pc(s).	5001.380

Assembly:

- The foamed-in PU seal can be removed without leaving a residue and the surface cleaned. The self-adhesive silicone seal must be pressed into the exact position, with the top horizontal sealing strip covering the vertical strip without any gap.

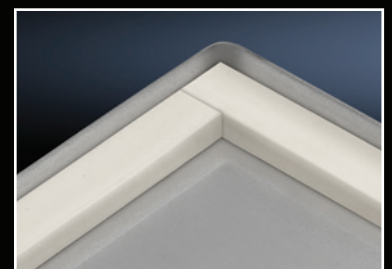
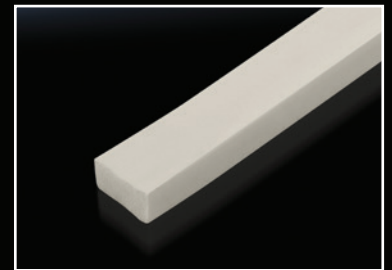

Hygienic Design

Accessories



Rails for interior installation for HD compact installation

For mounting on the existing threaded bolts. With TS system punchings on three sides.

Material:

- Sheet steel, zinc-plated

Supply includes:

- Assembly parts

Length in. (mm)	Packs on	Model No.
20" (510)	4 pc(s).	5001.050
27.9" (710)	4 pc(s).	5001.051
35.8" (910)	4 pc(s).	5001.052
43.7" (1110)	4 pc(s).	5001.053

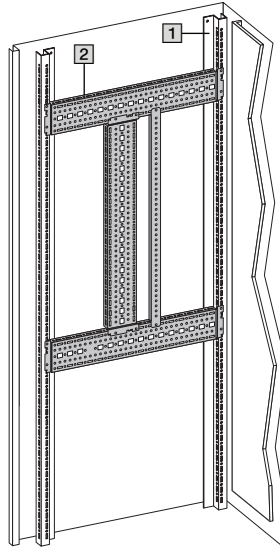

Interior installation, door

Enclosure	1	1	1
Model No.	Model No.		
1316.600	5001.052	5001.050	5001.050
1317.600	5001.053	5001.051 5001.050	5001.051 5001.050

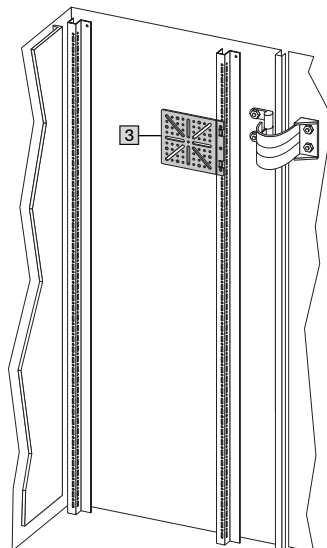

Interior installation, door

Enclosure	1	2	3
	Rails for interior installation 	TS punched section with mounting flange 17 x 73 mm 	Mounting plates
Model No.	Model No.	Model No.	
1308.600 1310.600 1315.600	5001.050	-	-
1316.600	5001.052	8612.130 (only on lock side)	8612.400 8612.410
1317.600	5001.053	8612.130 (only on lock side)	8612.400 8612.410

Hygienic Design

Accessories

HD cable gland

Applications:

- Food and beverage production
- Clean room technology (e.g. pharmaceuticals)
- Biotechnology
- Chemical industry

Benefits:

- Smooth, solid exterior surfaces effectively prevent the depositing of harmful micro-organisms
- Much easier, and therefore cheaper, to clean compared with conventional cable glands

Material:

- Cap nut: Stainless steel 1.4305 (AISI 303)
- Seal: Conforms to FDA 21 CFR 177.2600

Protection category IP to IEC 60 529:

- IP 68 (5 bar, 30 min.)

Protection category IP to DIN 40 050-9:

- IP 69K

Standard version

Size	Cable diameter in. (mm)	Packs of	Model No.
M12 x 1.5	0.1"-0.2"(3-6.5)	5 pc(s).	2410.000
M16 x 1.5	0.1"-0.3"(5-10)	5 pc(s).	2410.010
M20 x 1.5	0.2"-0.4"(6-12)	5 pc(s).	2410.020
M25 x 1.5	0.4"-0.6"(12-17)	5 pc(s).	2410.030

EMC version

Size	Cable diameter in. (mm)	Packs of	Model No.
M16 x 1.5	0.1"-0.3"(5-10)	5 pc(s).	2410.110
M20 x 1.5	0.2"-0.4"(6-12)	5 pc(s).	2410.120
M25 x 1.5	0.4"-0.6"(12-17)	5 pc(s).	2410.130

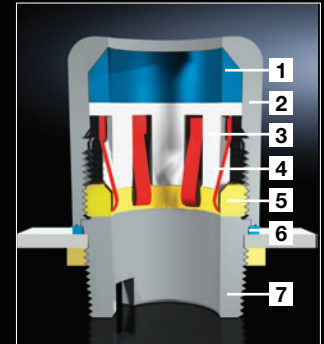

Why use hygiene-compatible cable glands

Critical points with conventional solutions

- 1 Cable entry in front of seal
- 2 No minimum radii on the hexagon
- 3 External threads
- 4 Gap caused by O-ring on the enclosure surface

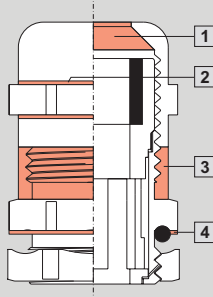

Hygiene-compatible design features

- 1 Seal directly at the cable entry
- 2 Compliance with minimum radii on the hexagon
- 3 No external threads
- 4 Flush termination between the cap nut and the enclosure

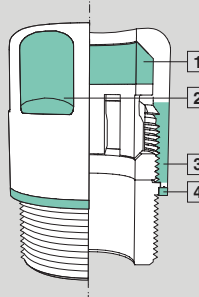

- 1 Seal
- 2 Cap nut
- 3 Gripper jaws
- 4 Shield spring (EMC version only)
- 5 Clamping ring
- 6 Enclosure seal
- 7 Base with locator for assembly tool

Stainless steel lock nut

To match HD cable glands

Material:

- Stainless steel 1.4305 (AISI 303)

Size	Packs of	Model No.
M12 x 1.5	10 pc(s).	2410.200
M16 x 1.5	10 pc(s).	2410.210
M20 x 1.5	10 pc(s).	2410.220
M25 x 1.5	10 pc(s).	2410.230

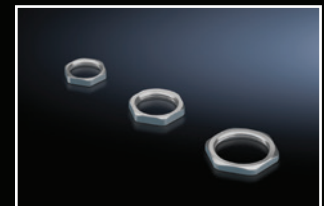

Assembly tool for HD cable gland

For attaching HD cable glands in an internal thread or using lock nuts. This can be achieved either from the inside or from the outside using an Allen key.

Supply includes:

- 1pc(s). = Adapter for sizes from M12 – M25

Packs of	Model No.
1 set(s)	2410.290

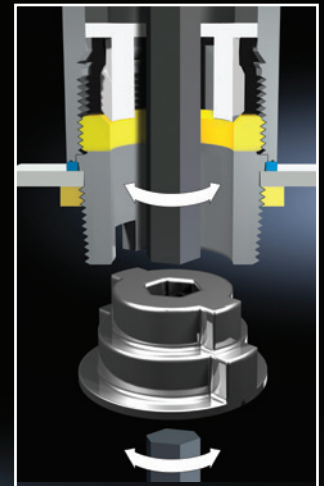

Rittal – The System.

Faster – better – everywhere.

- Enclosures
- Power Distribution
- Climate Control
- IT Infrastructure
- Software & Services

Scan the code
below to explore
Rittal Food
and Beverage
Industrial
Solutions.



Rittal North America LLC

Woodfield Corporate Center
425 North Martingale Road, Suite 400 • Schaumburg, Illinois 60173 • USA
Phone: 937-399-0500 • Toll-free: 800-477-4000
Email: rittal@rittal.us • Website: www.rittal.us

Rittal Systems Ltd.

6485 Ordan Drive • Mississauga, Ontario L5T 1X2 • Canada
Phone: 905-795-0777 • Toll-free: 800-399-0748
Email: marketing@rittal.ca • Website: www.rittal.ca

Rittal Mexico

Dr. Roberto Gayol 1219-1B • Col. Del Valle Sur, 03100 • Mexico, D.F.
Phone: (+52) (55) 5559-5369 • Toll-free: 01 800 8 Rittal (748.825)
Email: info@rittal.com.mx • Website: www.rittal.com.mx

US350 ■ 5/18

ENCLOSURES

POWER DISTRIBUTION

CLIMATE CONTROL

IT INFRASTRUCTURE

SOFTWARE & SERVICES

